

Work happily



V1.2

naggura'swop

[naggura.com](http://naggura.com)

# Our products

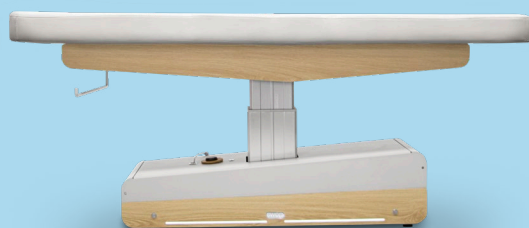

The Swop S3 SPA is an electrical 3-section table with a one-piece mattress and wooden structure.

Wood, Metal or Pmma



# Collections

Nordic  
METAL

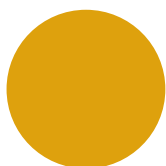

Yellow

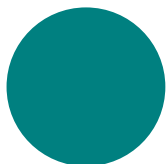

Blue

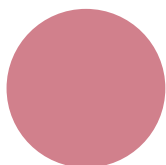

Pink

Foll  
METAL



Ash

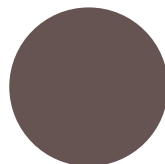

Clay

Iron  
METAL

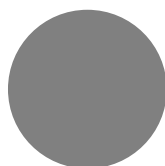

Inox

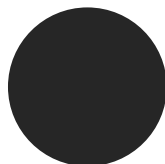

Black

Om  
WOOD



Oak



Wenge

Techno  
PMMA



Fluor

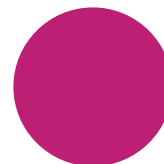

Fuxia



Ice

# SWOP S3 SPA



## Dimensions

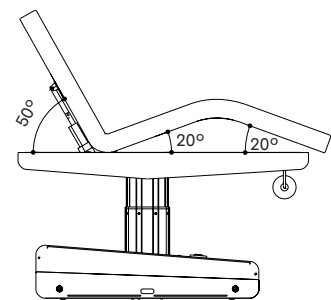
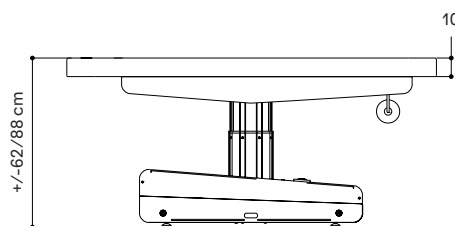
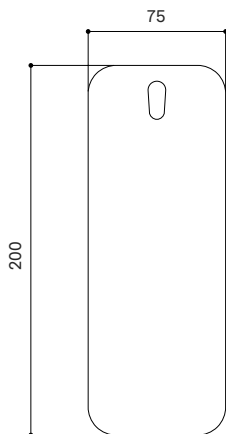

## General specifications

**MOTORS**  
3 engine (height, footrest, backrest)

**DIMENSIONS (LENGTH X WIDTH)**  
200 x 75 cm

**HEIGHT (MIN. AND MAX.)**  
62/88 cm

**WEIGHT**  
110 kg

**THICKNESS**  
10 cm

**DENSITY**  
30 kg/m<sup>3</sup>

**LIFTING CAPACITY**  
175 kg

**OPERATION**  
Hand controller (included)/  
Foot controller (optional)

**POWER SUPPLY**  
230 V - 50/60 Hz

**MAX. INTENSITY**  
2 A

**ELECTRIC MOTOR**  
6.000 N

**CUSHION**

Upholstery Seamless round edges.

Naggura Skin upholstery:  
100% vinyl compound in white.

Superior abrasion resistance: >250.000 cycles.  
Protection against germs and UV rays.