

**Lemi**<sup>®</sup>  
ITALIAN WELLNESS EQUIPMENT



WATER

*The WATER line includes unique up-to-date spa equipment specific for Spa treatments with water, steam bath, hydrotherapy treatments, massages, professional manicure and pedicure.*

La linea WATER include delle attrezzature spa che presentano una tecnologia avanzata specifica per trattamenti Spa con acqua, bagni di vapore, trattamenti di idroterapia, massaggi, manicure e pedicure professionale.



WATER

# ELBA PEDI SPA

ELBA PEDI SPA



\* B: Bianco ghiaccio 410 | M: Nefos 991

## COD. 857

*Elba PEDI Spa is the entry-level pedicure station featuring modern lines and elegant forms that enrich with charm and design any kind of environment, making the 3 available treatments - pedicure, manicure and facial - a moment of unique relaxation and intense pleasure. Equipped with Pipeless Hydromassage, 180° chair rotation, backrest with gas-spring. Customizable finishes.*

*IDEAL FOR: spa manicure and spa pedicure, facial treatments.*

Elba PEDI Spa è la postazione pedicure entry-level caratterizzata da linee moderne e forme eleganti, che arricchiscono di fascino e suggestione ogni tipologia di ambiente, trasformando i 3 trattamenti disponibili - pedicure, manicure e viso - in un unico momento di raffinato relax. Dotata di Hydromassage Pipeless, rotazione della poltrona di 180°, schienale con molla a gas. Finiture personalizzabili.

IDEALE PER: spa manicure e spa pedicure, trattamenti viso.

*\* The images are for illustrative purposes only and may not reflect the actual image of the finishing.*

*\* Le immagini hanno valore puramente illustrativo e possono non rispecchiare l'immagine reale della finitura.*

## Focus on

- Pipeless Hydromassage system guaranteeing maximum hygiene and ease of cleaning
  - 180° manual chair rotation
  - Backrest with gas-spring adjustment
  - Manually adjustable footrest
  - Easy-to-clean manicure bowl
  - Slim padding and customizable finishes
  - Perfect for pedicure, manicure and facial treatments
- Sistema di idromassaggio "pipeless" che garantisce la massima igiene e semplicità di pulizia
  - Rotazione manuale della poltrona di 180°
  - Schienale regolabile mediante molla a gas
  - Poggia piedi regolabile manualmente
  - Bacinelle manicure facili da igienizzare
  - Imbottitura sottile con rivestimento personalizzabile
  - Perfetta per trattamenti piedi, mani e viso

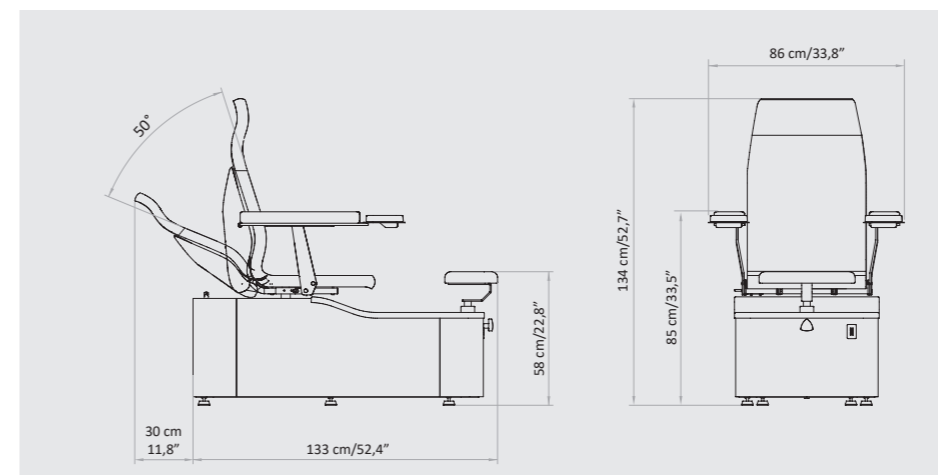

## Packaging details

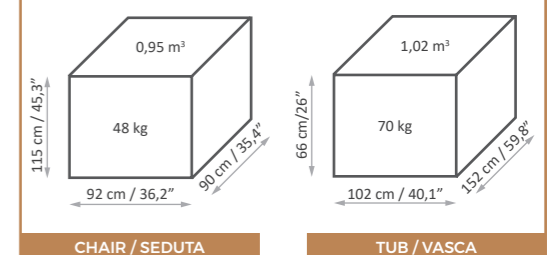

CHAIR / SEDUTA

TUB / VASCA



MAXIMUM CAPACITY  
PORTATA MASSIMA

200 kg



# MATTRESS CUSTOMIZATION PERSONALIZZAZIONE MATERASSO

VITA - COLOR CHART

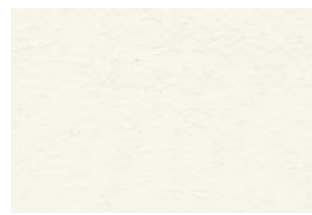

EV00021



EV00022



EV00041



EV00042

SPA PRESTIGE - COLOR CHART



9916

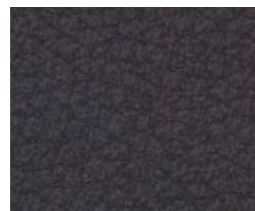

1424

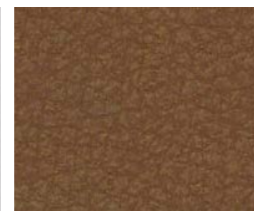

1423

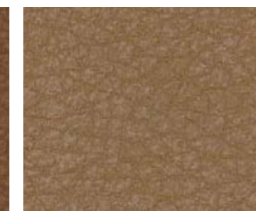

1422

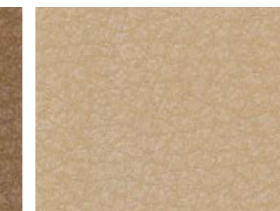

2202



2204



7022



7023

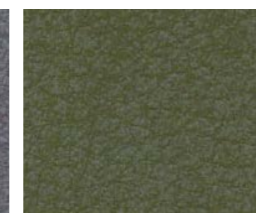

1875

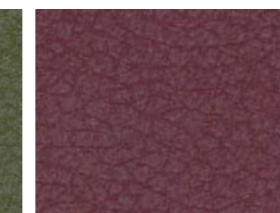

1530

NEFOS - COLOR CHART

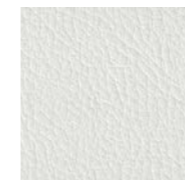

6



1957



6985



3962

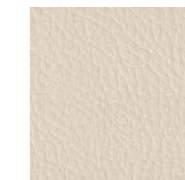

1155

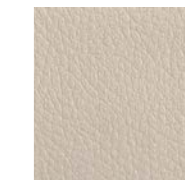

2124



1194



2173



6986



569

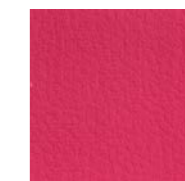

667



680



64



71

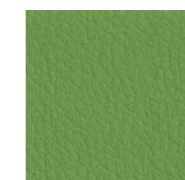

1868



1843

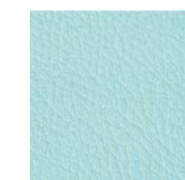

8019

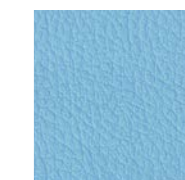

8009



5946



6940



6941



6942



1388

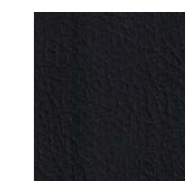

991

The images are for illustrative purposes only and may not reflect the actual finish of the product, particularly when viewed through a screen. Therefore, the **SELECTION OF THE FINISHES** of the **BASES** and **MATTRESS FABRICS** must take place **AFTER CONSULTING** the **LUXURY BOX PHYSICAL SAMPLES** and the **COLOR CHARTS**.

The innovative VITA (consisting of 80% natural and renewable components), Spa Prestige and Nefos materials - which are exclusive for LEMI products - and their special finishing touch guarantee easy-cleaning and hygiene. Their extraordinary structural qualities will persist through the years. An incredibly elastic texture enhances the memory foam mattress softness and quality at its best, giving Spa Clients a complete and satisfying wellness experience.

Gli innovativi materiali VITA (costituiti per l'80% da componenti naturali e rinnovabili), Spa Prestige e Nefos - che sono un'esclusiva dei prodotti LEMI - ed il loro speciale tocco di finitura garantiscono una facile pulizia e igiene. Le loro straordinarie qualità strutturali permangono nel corso degli anni. Una texture incredibilmente elastica migliora al massimo la morbidezza e la qualità del materasso in Memory Foam, dando ai clienti Spa un'esperienza di benessere completa e soddisfacente.

Le immagini hanno valore puramente illustrativo e possono non rispecchiare la finitura reale del prodotto, in particolare se visualizzate attraverso uno schermo. Pertanto la **SELEZIONE DELLE FINITURE** delle **BASI** e dei **RIVESTIMENTI** dei **MATERASSI** deve avvenire **PREVIA CONSULTAZIONE** della **CAMPIONATURA FISICA** della **LUXURY BOX** e delle **CARTELLE COLORI**.

# BASE CUSTOMIZATION PERSONALIZZAZIONE BASE

## ALFA - FINISHES CHART



Today, 70% of the company's wooden equipment and treatment tables are manufactured using FSC certified lumber from unprotected forests. The woods are furnished by suppliers that have committed themselves to sustainable development, guaranteeing full compliance with the best environmental protection practices.

Oggi, il 70% delle attrezzature e dei lettini in legno dell'azienda sono realizzati con legname certificato FSC proveniente da foreste non protette. I legni provengono da fornitori che si sono impegnati per lo sviluppo sostenibile, garantendo il pieno rispetto delle migliori pratiche di tutela ambientale.

The images are for illustrative purposes only and may not reflect the actual finish of the product, particularly when viewed through a screen. Therefore, the **SELECTION OF THE FINISHES** of the **BASES** and **MATTRESS FABRICS** must take place **AFTER CONSULTING** the **LUXURY BOX PHYSICAL SAMPLES** and the **COLOR CHARTS**.

Le immagini hanno valore puramente illustrativo e possono non rispecchiare la finitura reale del prodotto, in particolare se visualizzate attraverso uno schermo. Pertanto la **SELEZIONE DELLE FINITURE** delle **BASI** e dei **RIVESTIMENTI** dei **MATERASSI** deve avvenire **PREVIA CONSULTAZIONE** della **CAMPIONATURA FISICA** della **LUXURY BOX** e delle **CARTELLE COLORI**.

# ACCESSORIES UPON REQUEST ACCESSORI SU RICHIESTA

All tables have a standard setting customizable upon request.

Tutti i lettini hanno una configurazione standard personalizzabile su richiesta.

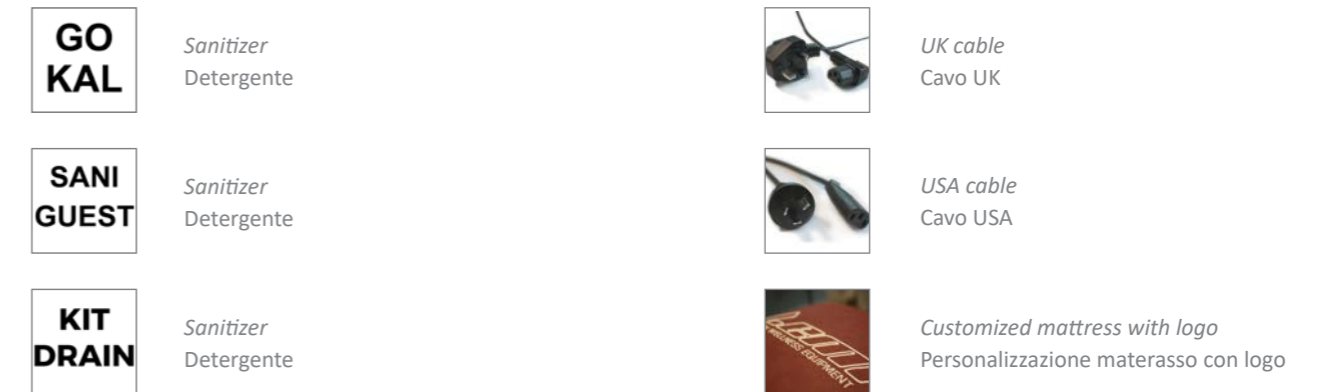

# TECHNICAL REQUIREMENTS

## CARATTERISTICHE TECNICHE

ABSORPTION ASSORBIMENTO	VOLTAGE VOLTAGGIO	POWER POTENZA	FREQUENCY FREQUENZA	WARRANTY	GARANZIA
8,4 Amax (4,6 A)	120 Vac (220Vac)	1008W	50/60 Hz	<i>Electric parts and controls: 2 years</i> <i>Undeformable foam: 5 years</i> <i>Structure: 10 years</i>	<i>Parti elettriche e comandi: 2 anni</i> <i>Gomma indeformabile: 5 anni</i> <i>Struttura: 10 anni</i>

### REGULATIONS

All Equipment is  marked

#### Electrical equipment and beds

Directive 2006/42/CE (Machinery Directive) and national regulations

Directive 2014/30/UE (Electromagnetic Compatibility Directive) and national regulations.

#### Images

The images are for illustrative purposes only and may not reflect the actual image of the product.

### NORME

Tutte le attrezzature sono a marchio 

#### Attrezzature e lettini elettrici

Direttiva 2006/42/CE (Direttiva Macchine) e disposizioni nazionali di attuazione

Direttiva 2014/30/UE (Direttiva Compatibilità elettromagnetica) e disposizioni nazionali di attuazione.

#### Immagini

Le immagini hanno valore puramente illustrativo e possono non rispecchiare l'immagine reale del prodotto.

**Lemi**<sup>®</sup>  
ITALIAN WELLNESS EQUIPMENT

#### Brusafferri & C srl

Via Mara Maretti Soldi, 13  
26011 Casalbuttano (CREMONA) ITALY  
Phone +39-0374-363069 Fax +39-0374-363071  
info@lemigroup.it service@lemigroup.it

www.lemigroup.it