

Lemi[®]
ITALIAN WELLNESS EQUIPMENT



ESSENTIAL

All the massage tables of the ESSENTIAL line feature the electric height adjustment and the possibility to adjust the back or the leg manually.

Tutti i lettini della linea ESSENTIAL presentano la regolazione elettrica dell'altezza e la possibilità di regolare lo schienale o la gamba manualmente.



Horseshoe headrest / Testa a ferro di cavallo



COD. 916

Thanks to its essential lines, Bellagio 1M is perfectly suitable for any kind of treatment room. The electric height adjustment and the manual back make it practical and versatile.

IDEAL FOR: massages, face and body treatments, hair removal, treatments with aesthetic equipment.

Grazie alle sue linee essenziali, Bellagio 1M si adatta perfettamente a tutti i tipi di cabina. Le regolazione elettrica dell'altezza e lo schienale manuale ne rendono l'utilizzo pratico e versatile.

IDEALE PER: massaggi, trattamenti viso e corpo, depilazione, trattamenti con apparecchiature estetiche.



* The images are for illustrative purposes only and may not reflect the actual image of the finishing.

* Le immagini hanno valore puramente illustrativo e possono non rispecchiare l'immagine reale della finitura.

* B: Rovere Axe 4208 | M: Nefos 1155

Version with XL mattress / Versione con materasso XL

Focus on

- 1 electric motor for height adjustment
- 2 sections mattress with horseshoe headrest
- Gas spring for backrest adjustment
- Fire resistant, "Azo" free, antibacterial and antifungal mattress covering
- An ideal solution for multi-rooms

NEW

- 1 motore elettrico per la regolazione dell'altezza
- Materasso a 2 sezioni con testa a ferro di cavallo
- Schienale regolabile con molla a gas
- Rivestimento ignifugo, "Azo" free, antibatterico, antimicotico
- Soluzione ideale per cabine multifunzionali

NEW

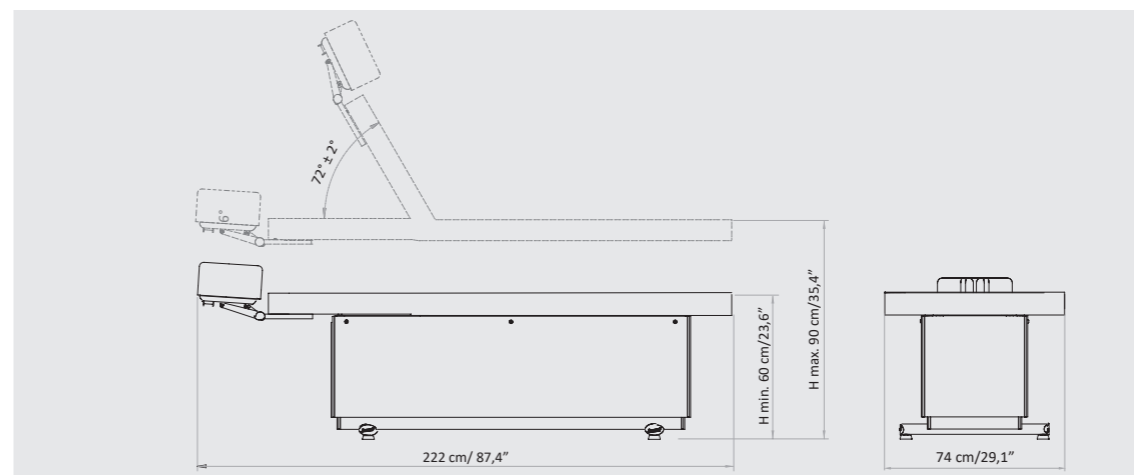

Packaging details

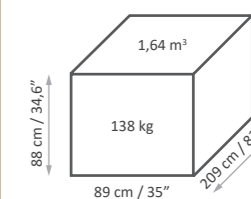

MAXIMUM CAPACITY
PORTATA MASSIMA
200 kg

MATTRESS CUSTOMIZATION PERSONALIZZAZIONE MATERASSO

VITA - COLOR CHART



EV00021



EV00022



EV00041



EV00042

SPA PRESTIGE - COLOR CHART



9916

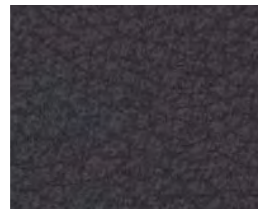

1424

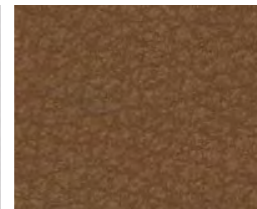

1423

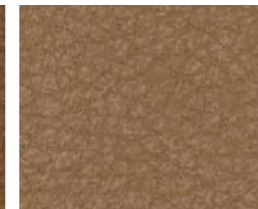

1422

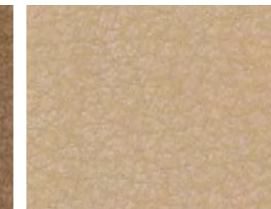

2202



2204

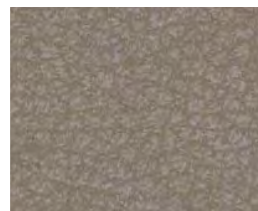

7022

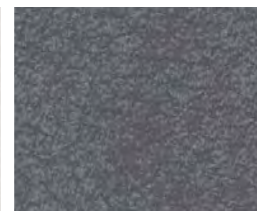

7023

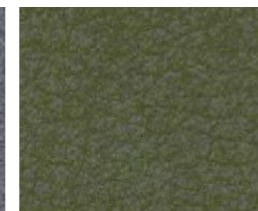

1875

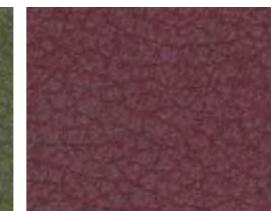

1530

NEFOS - COLOR CHART

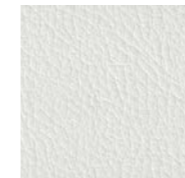

6



1957



6985



3962

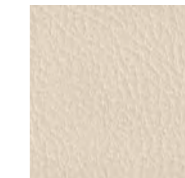

1155

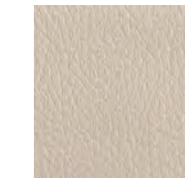

2124



1194



2173

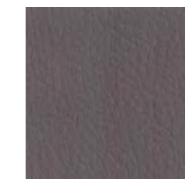

6986



569

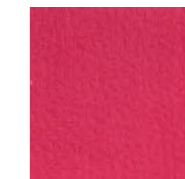

667



680



64



71



1868



1843

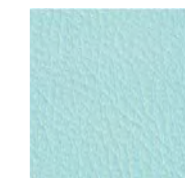

8019

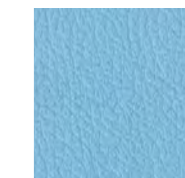

8009



5946



6940



6941

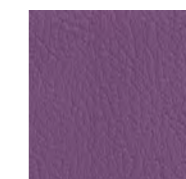

6942



1388

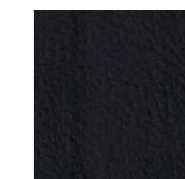

991

The images are for illustrative purposes only and may not reflect the actual finish of the product, particularly when viewed through a screen. Therefore, the **SELECTION OF THE FINISHES** of the **BASES** and **MATTRESS FABRICS** must take place **AFTER CONSULTING** the **LUXURY BOX PHYSICAL SAMPLES** and the **COLOR CHARTS**.

The innovative VITA (consisting of 80% natural and renewable components), Spa Prestige and Nefos materials - which are exclusive for LEMI products - and their special finishing touch guarantee easy-cleaning and hygiene. Their extraordinary structural qualities will persist through the years. An incredibly elastic texture enhances the memory foam mattress softness and quality at its best, giving Spa Clients a complete and satisfying wellness experience.

Gli innovativi materiali VITA (costituiti per l'80% da componenti naturali e rinnovabili), Spa Prestige e Nefos - che sono un'esclusiva dei prodotti LEMI - ed il loro speciale tocco di finitura garantiscono una facile pulizia e igiene. Le loro straordinarie qualità strutturali permangono nel corso degli anni. Una texture incredibilmente elastica migliora al massimo la morbidezza e la qualità del materasso in Memory Foam, dando ai clienti Spa un'esperienza di benessere completa e soddisfacente.

Le immagini hanno valore puramente illustrativo e possono non rispecchiare la finitura reale del prodotto, in particolare se visualizzate attraverso uno schermo. Pertanto la **SELEZIONE DELLE FINITURE** delle **BASI** e dei **RIVESTIMENTI** dei **MATERASSI** deve avvenire **PREVIA CONSULTAZIONE** della **CAMPIONATURA FISICA** della **LUXURY BOX** e delle **CARTELLE COLORI**.

BASE CUSTOMIZATION PERSONALIZZAZIONE BASE



Today, 70% of the company's wooden equipment and treatment tables are manufactured using FSC certified lumber from unprotected forests. The woods are furnished by suppliers that have committed themselves to sustainable development, guaranteeing full compliance with the best environmental protection practices.

Oggi, il 70% delle attrezzature e dei lettini in legno dell'azienda sono realizzati con legname certificato FSC proveniente da foreste non protette. I legni provengono da fornitori che si sono impegnati per lo sviluppo sostenibile, garantendo il pieno rispetto delle migliori pratiche di tutela ambientale.

The images are for illustrative purposes only and may not reflect the actual finish of the product, particularly when viewed through a screen. Therefore, the **SELECTION OF THE FINISHES** of the **BASES** and **MATTRESS FABRICS** must take place **AFTER CONSULTING** the **LUXURY BOX PHYSICAL SAMPLES** and the **COLOR CHARTS**.

Le immagini hanno valore puramente illustrativo e possono non rispecchiare la finitura reale del prodotto, in particolare se visualizzate attraverso uno schermo. Pertanto la **SELEZIONE DELLE FINITURE** delle **BASI** e dei **RIVESTIMENTI** dei **MATERASSI** deve avvenire **PREVIA CONSULTAZIONE** della **CAMPIONATURA FISICA** della **LUXURY BOX** e delle **CARTELLE COLORI**.

ACCESSORIES UPON REQUEST ACCESSORI SU RICHIESTA

All tables have a standard setting customizable upon request.

Tutti i lettini hanno una configurazione standard personalizzabile su richiesta.

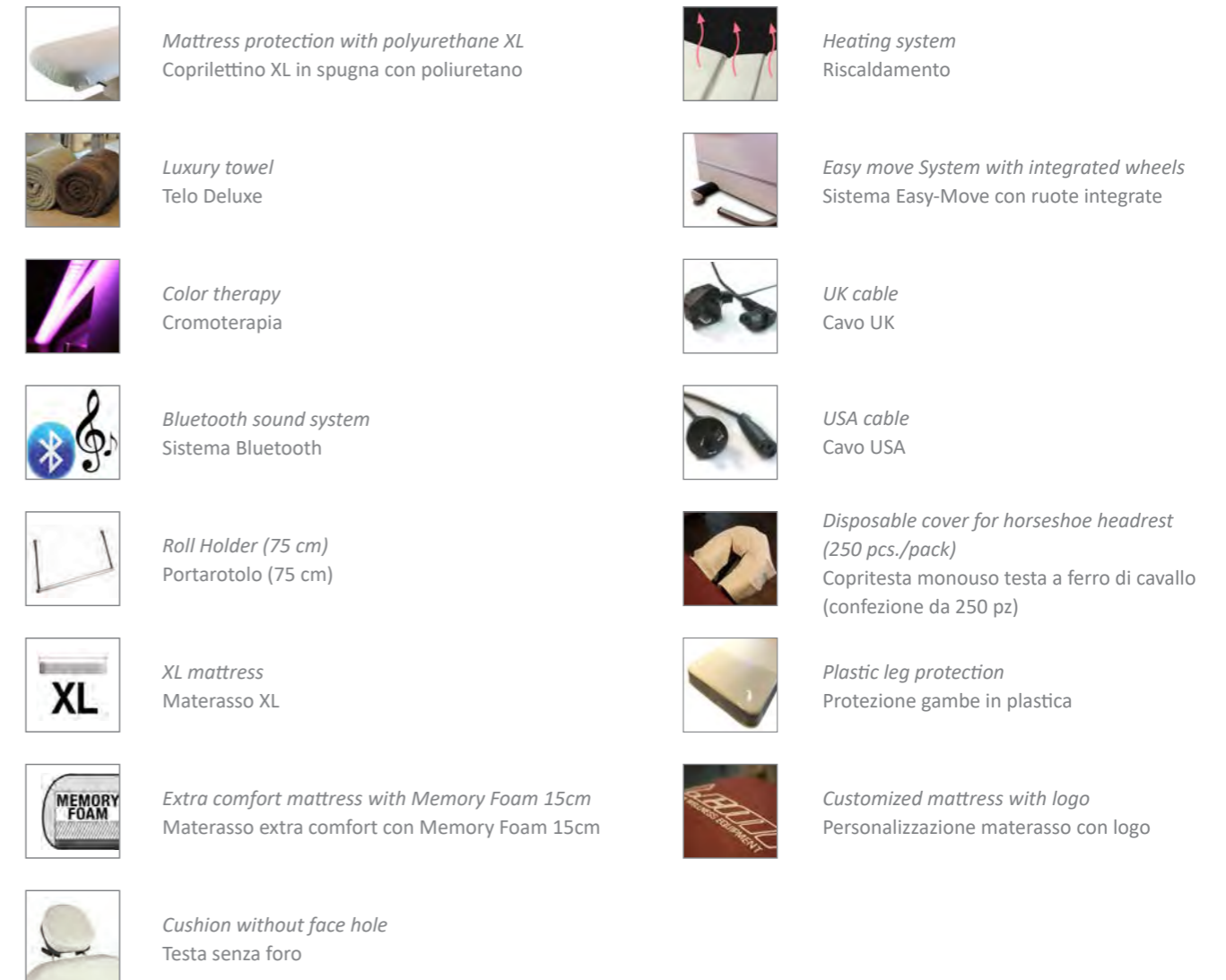

LEMI MATTRESSES

The **MATTRESSES** of the **ESSENTIAL** line are made with the best quality materials to ensure great stability and maximum hygienisation.

Each mattress is **HANDCRAFTED**, therefore the **ACTUAL MEASUREMENTS MAY VARY** from those indicated in the catalog.

MATERASSI LEMI

I **MATERASSI** della linea di **ESSENTIAL** sono realizzati con materiali della migliore qualità per garantire un'elevata stabilità e la massima igienizzazione.

Ogni materasso è realizzato **A MANO**, pertanto le **MISURE REALI POTREBBERO VARIARE** rispetto a quelle indicate nel catalogo.

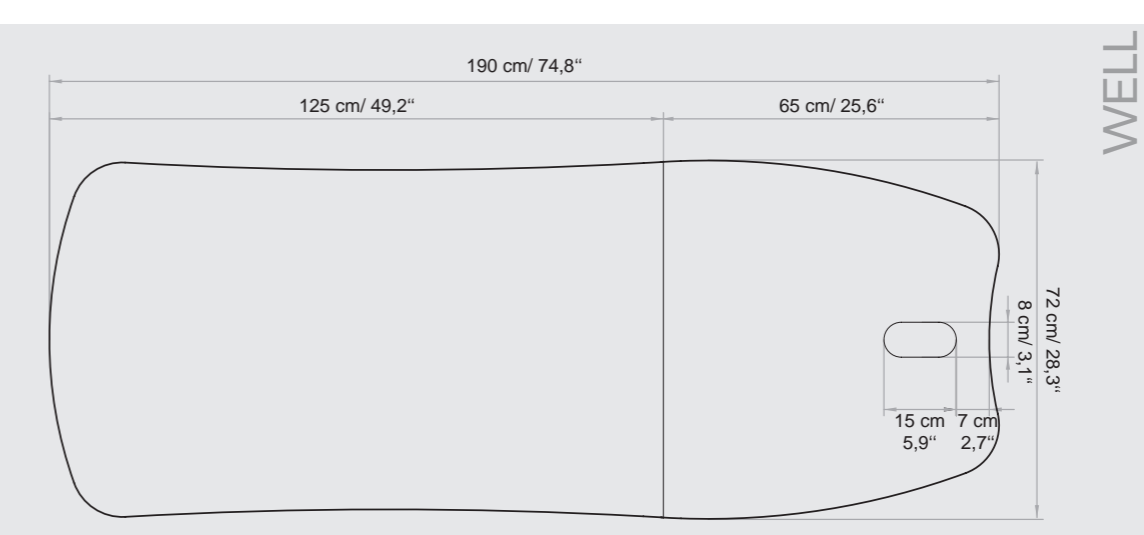
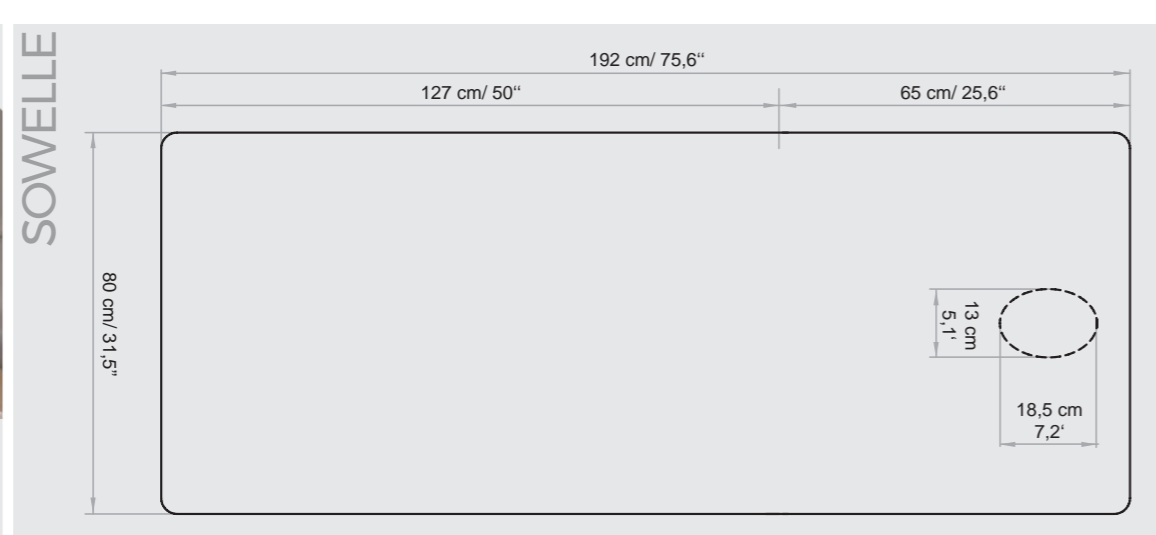
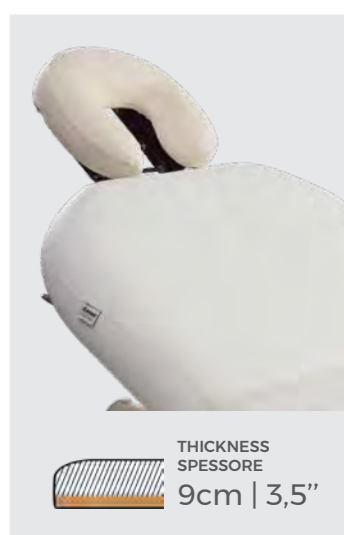
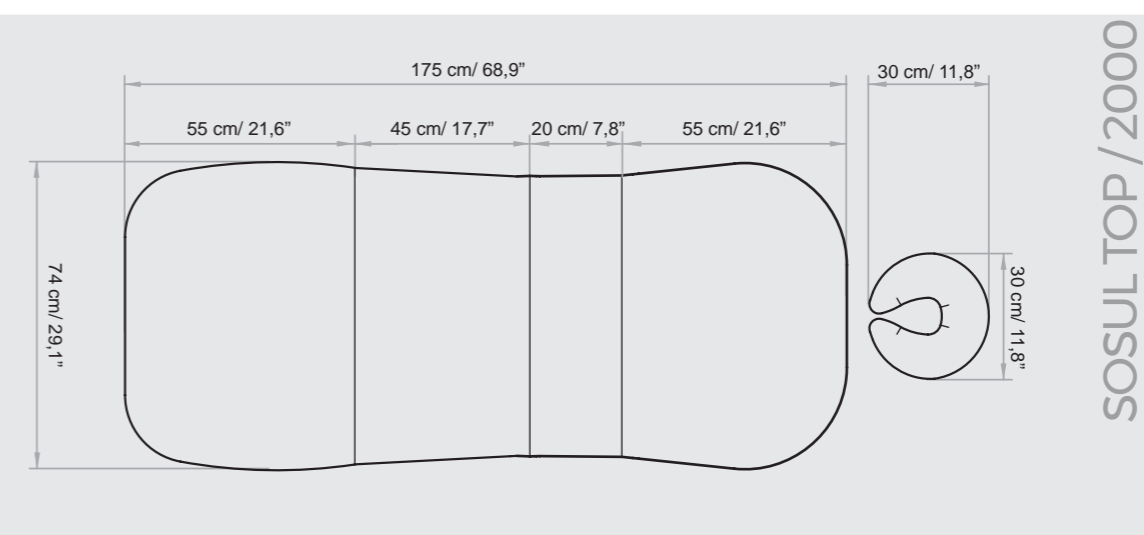
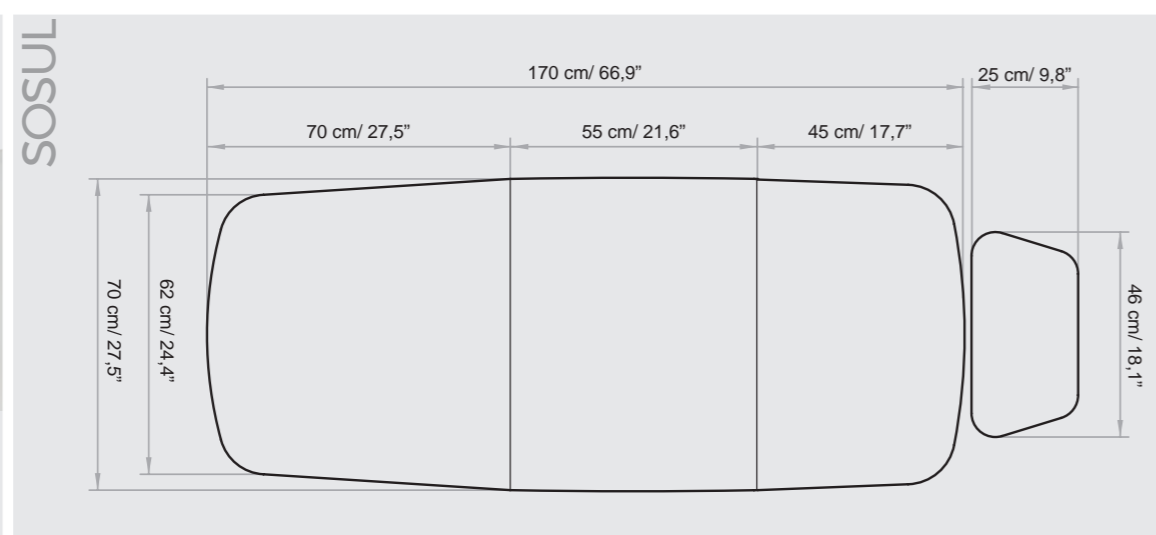
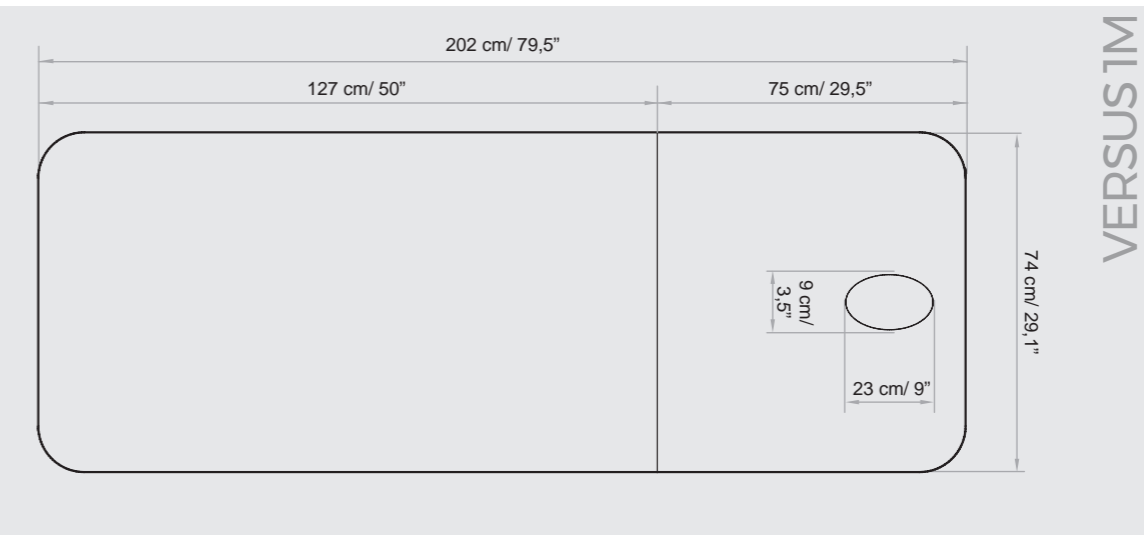
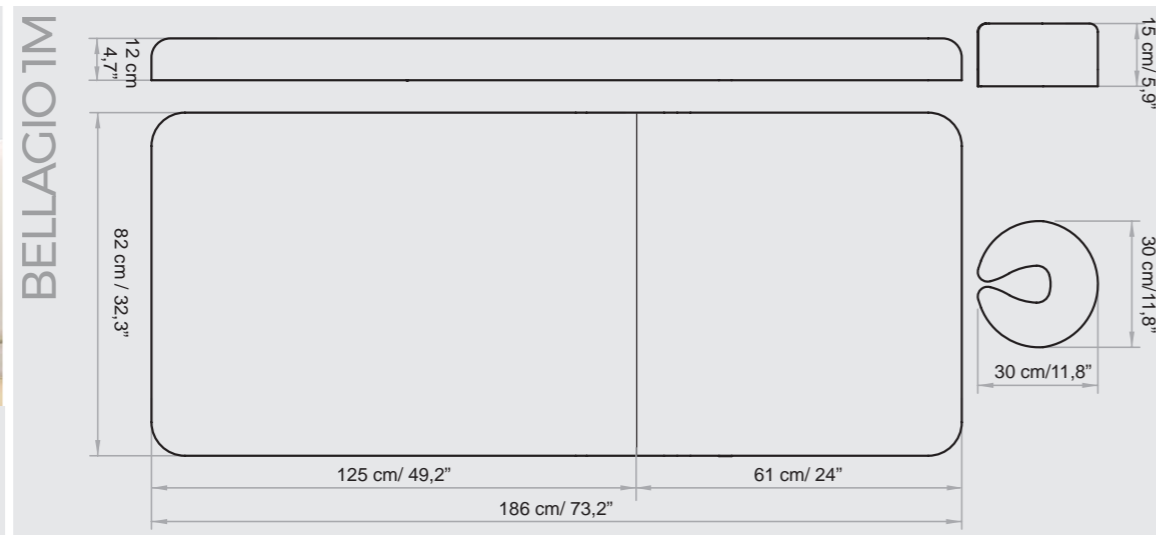

TECHNICAL REQUIREMENTS

CARATTERISTICHE TECNICHE

ABSORPTION ASSORBIMENTO	VOLTAGE VOLTAGGIO	POWER POTENZA	FREQUENCY FREQUENZA	WARRANTY	GARANZIA
4 Amax (1,7 A)	100 Vac (240Vac)	250W	50/60 Hz	<i>Mattress heating: 1 year</i> <i>Electric parts and controls: 2 years</i> <i>Undeformable foam: 5 years</i> <i>Structure: 10 years</i>	Riscaldamento materasso: 1 anno Parti elettriche e comandi: 2 anni Gomma indeformabile: 5 anni Struttura: 10 anni

REGULATIONS

All Equipment is  marked

Electrical equipment and beds

Directive 2006/42/CE (Machinery Directive) and national regulations

Directive 2014/30/UE (Electromagnetic Compatibility Directive) and national regulations.

Images

The images are for illustrative purposes only and may not reflect the actual image of the product.

NORME

Tutte le attrezzature sono a marchio 

Attrezzature e lettini elettrici

Direttiva 2006/42/CE (Direttiva Macchine) e disposizioni nazionali di attuazione

Direttiva 2014/30/UE (Direttiva Compatibilità elettromagnetica) e disposizioni nazionali di attuazione.

Immagini

Le immagini hanno valore puramente illustrativo e possono non rispecchiare l'immagine reale del prodotto.

Lemi[®]
ITALIAN WELLNESS EQUIPMENT

Brusaferrì & C srl

Via Mara Maretti Soldi, 13
26011 Casalbuttano (CREMONA) ITALY
Phone +39-0374-363069 Fax +39-0374-363071
info@lemigroup.it service@lemigroup.it

www.lemigroup.it